

Delta-Q IC650

650W Industrial Battery Charger

Installation and Design Guide



Delta-Q Technologies Corp.
3755 Willingdon Avenue
Burnaby, BC V5G 3H3
CANADA

Web: www.delta-q.com
Phone: +1.604.327.8244
E-mail: info@delta-q.com

Delta-Q IC650 Design Guide: Table of Contents

1.0 Safety Notes	3
2.0 Regulatory Notes	4
3.0 IC650 Charger Operations	5
4.0 Charger Interface	8
5.0 Mechanical Installation	10
6.0 Electrical Installation	13
7.0 Communications	20
8.0 IC650 Configuration	21
9.0 Troubleshooting	23
10.0 Detailed Specifications & Performance	26
11.0 Replacement Parts List	34
12.0 Glossary	35

Intended Audience

This document is intended for engineers and technologists of Original Equipment Manufacturers (OEM) to aid them in incorporating the Delta-Q IC650 Charger into their products.

1.0 Safety Notes

Read and comprehend this document fully before handling or working with the IC650 Charger. Important safety, operation, and installation instructions are included.

High Voltage Safety

WARNING: This product can contain potentially lethal levels of voltage. Exercise extreme care when working with the equipment.

WARNING: DO NOT open the case of the charger. No user-serviceable parts are contained inside the unit.

Electrical Safety Information



Danger: Risk of electric shock. Connect charger power cord to an outlet that has been properly installed and grounded in accordance with all local codes and ordinances. A grounded outlet is required to reduce risk of electric shock – do not use ground adapters or modify plug. Do not touch uninsulated portion of output connector or uninsulated battery terminal. Disconnect the AC supply before making or breaking the connections to the battery while charging. Do not open or disassemble charger. Do not operate charger if the AC supply cord is damaged or if the charger has received a sharp blow, been dropped, or otherwise damaged in any way—refer all repair work to qualified personnel. Not for use by children.

Battery Safety Information



Warning: Use charger only on appropriate battery systems. Other usage may cause personal injury and damage. Study all battery manufacturers' specific precautions, such as recommended rates of charge and other safety precautions before charging batteries.

Precautions

Hot Surfaces



During charging, the surface of the charger may become hot to the touch, especially in higher ambient temperatures. This is normal. Avoid touching the surface of the charger.

Extension Cord Rating

Extension cords used with the charger must have appropriate ratings for the country in which it is used (e.g. an UL rating in the United States of America).

2.0 Regulatory Notes

North America

This equipment has been tested and found to comply with the limits for a Class A digital device, pursuant to Part 15 of the FCC Rules. These limits are designed to provide reasonable protection against harmful interference when the equipment is operated in a commercial environment. This equipment generates, uses, and can radiate radio frequency energy and, if not installed and used in accordance with the instruction manual, may cause harmful interference to radio communications. Operation of this equipment in a residential area is likely to cause harmful interference in which case the user will be required to correct the interference at their own expense.

All Delta-Q IC650 Chargers are fully compliant with safety regulatory requirements in Canada and the United States, as indicated by the "C" before and the "US" after the "CSA" logo.

All Delta-Q IC650 Chargers are fully compliant with California Energy Commission (CEC) standards for efficiency, and are marked with the CEC compliance symbol.

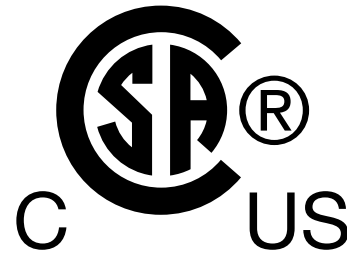

Europe, Asia, Middle East, Africa

Certification to the CE standard is currently pending.

Every effort has been made to ensure the IC650 Charger is fully compliant with most worldwide regulations. If a particular region does not accept the above regulatory approvals for this product, contact Delta-Q Technologies for further information and assistance.

Copies of all approvals for the Delta-Q IC650 Charger are available upon request.

3.0 IC650 Charger Operations

The Delta-Q IC650 Industrial Battery Charger is a 650-watt intelligent, programmable power device designed to reliably charge your machine’s batteries in the harshest of environments. It is intended to be installed on-board or off-board and, if desired, can be fully controlled by your own machine control module. The charger also provides electrical protection to help maintain the integrity of your vehicle’s electrical system and protect your users.

3.1 Overview

As an advanced power conversion device, the Delta-Q IC650 Charger efficiently provides clean DC output in a very compact package. It does this using a small, light, high-frequency switching transformer while still incorporating a utility-friendly power factor correction stage. The charger’s overall design is also optimized for maximum ruggedness and reliability to provide many years of service.

Isolation

Delta-Q has developed an innovative system of isolation boundaries to separate the IC650 Charger’s advanced features into four galvanically-isolated electrical domains:

- i. AC Input: Isolated input to AC source (0-270VAC)
- ii. DC Output: Isolated output to batteries (0 V - 3 Vpc DC)
- iii. LV: Isolation for USB and other signals (0-5V DC)
- iv. ELV: Isolation for CAN bus (0-5 VDC)

Configurations

The Delta-Q IC650 Charger has two primary configurations. The only difference between the models is the inclusion of a communication port on the “Comm” model for the purpose of advanced control communication.

1. Comm: Full CAN bus control and other signals available.

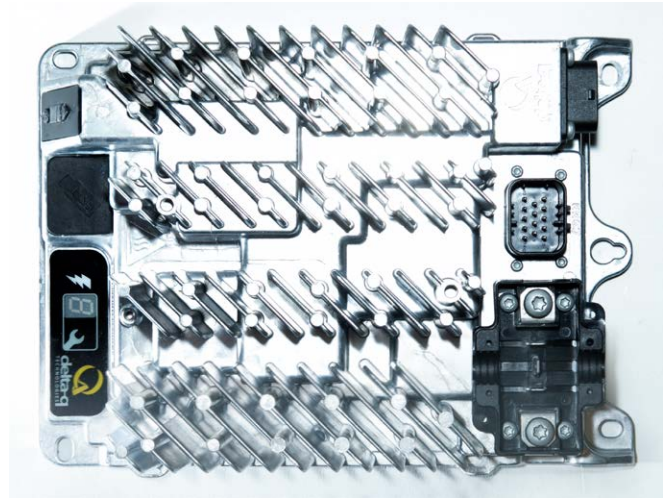

Figure 1. IC650 “Comm” model (overhead view)

2. Base: Base model connections to the battery and controller interlock.

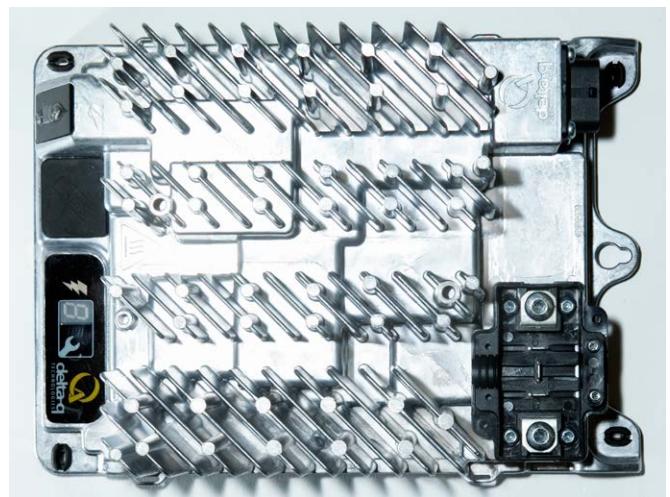

Figure 2. IC650 Base model (overhead view)

Either of the above can be configured for on-board or off-board use. For more details, please see the “[Electrical Installation](#)” section of this design guide.

3.2 Normal Operation

To begin charging in an on-board or off-board configuration, the battery pack must be within the voltage operation range of the selected charge profile and the AC voltage must be within range. For details of CAN bus controlled charging or using the charger as a power supply with simple PWM control (non-CAN bus), please see the [Communications](#) section.

The IC650 Charger operates in an on-board configuration (charge on AC detect) or off-board configuration [charge on DC (battery) detect]. Once the battery pack is fully charged, and if the IC650 Charger, battery pack and AC input remain connected, the charger will continue to monitor and maintain the battery.

On-board configuration: Charge on AC detect

The IC650 Charger is permanently connected to the battery pack. Charging begins when AC input is applied to the charger and will continue until the batteries are fully charged. The IC650 Charger enters monitor / maintain mode when charging is complete and charger remains connected to AC input.

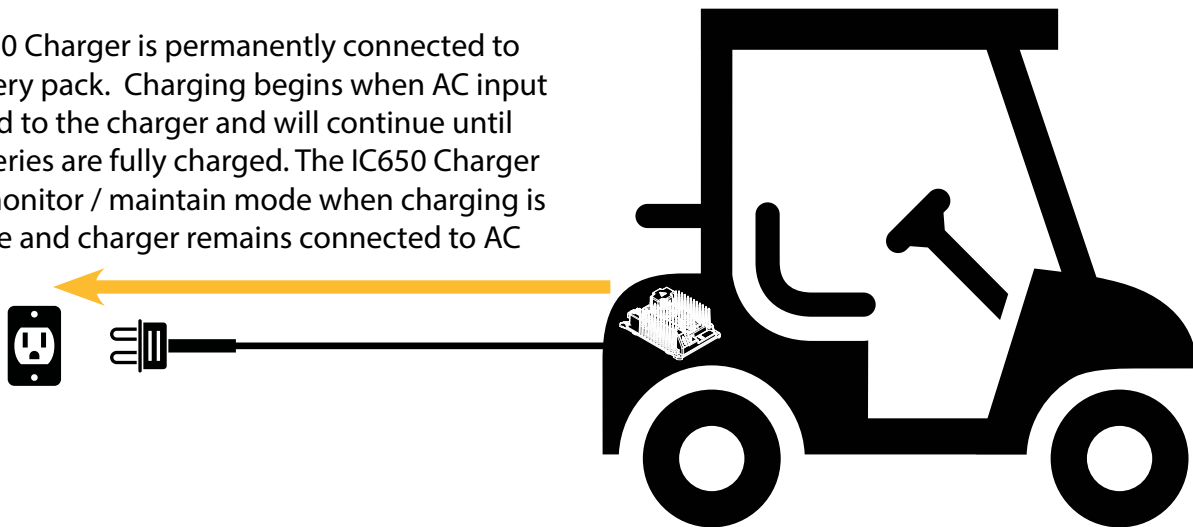

Off-board configuration: Charge on DC (battery) detect

The IC650 Charger is permanently connected to AC power. Charging begins when the battery pack is connected to the charger and will continue until charging is complete. The IC650 Charger enters monitor / maintain mode when charging is complete and charger remains connected to the battery pack.

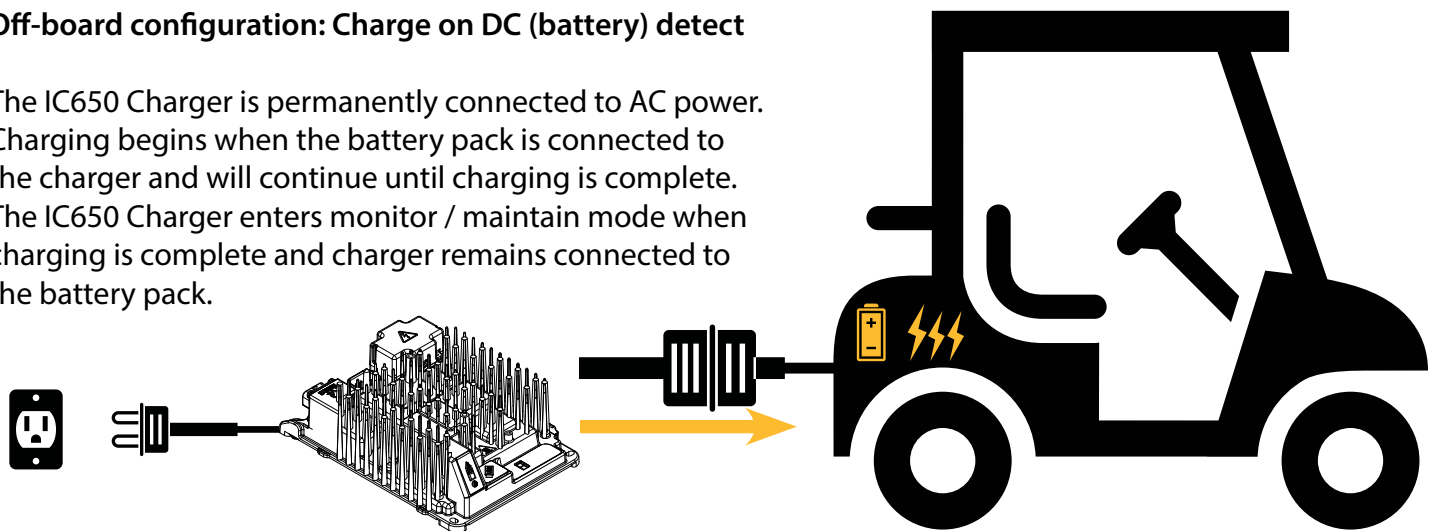

Monitor / maintain mode

This mode becomes active when the charging profile is complete, AC power is present and the battery pack is connected. The IC650 Charger output is disabled and the charger monitors the batteries. If the batteries fall below set thresholds or beyond set time limits for the charge profile, the charger will take action to preserve the life of the batteries. Depending on the selected algorithm, the charger will restart after 30 days or 2.08 V/cell, or after 18 days and 1.75 V/cell.

3.3 Adverse Operation

See the “Performance Charts” section for larger versions of these performance graphs.

High Ambient Temperature

At ambient temperatures above approximately 40°C, the charger will de-rate its output in order to maintain a maximum internal temperature. This de-rating is approximately linear until 0% output power at over 80°C ambient temperature.

As with any thermodynamic system, there are many variables to consider such as the volume and speed of airflow, ventilation, air currents, and emissivity effects that all influence the thermal performance of the charger. Thorough thermal testing is recommended in the final installation to determine actual performance.

Low Ambient Temperature

The IC650 Charger is capable of operating at full power at its minimum rated ambient temperature of -40°C. Figure 3 illustrates the approximate ambient temperature performance.

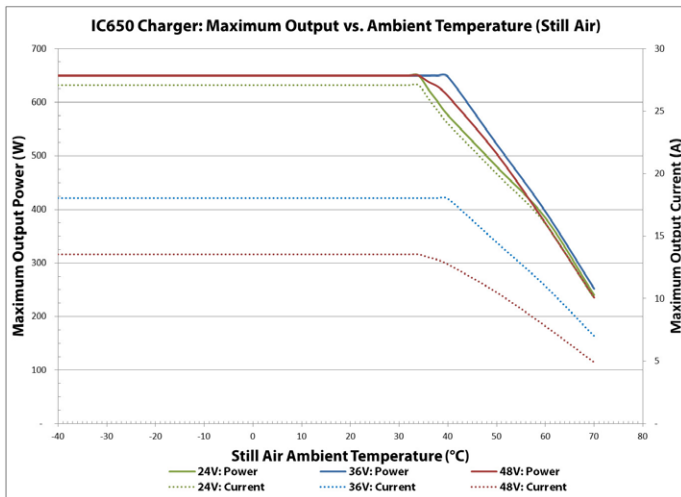

Figure 3. Ambient Temperature Derating

Low AC Voltage

Should input voltage fall below 100VAC, the charger will reduce output power in order to protect itself from damage. The power is reduced 1% per Volt below 100VAC until the charger turns off at 80VAC. Turn-on occurs when the voltage rises above 85VAC.

High AC Voltage

When input voltage rises above 270VAC the charger will shut off in order to protect itself from damage. It will not turn on until the voltage falls below 265VAC. Figure 4 shows the power across the AC voltage range.

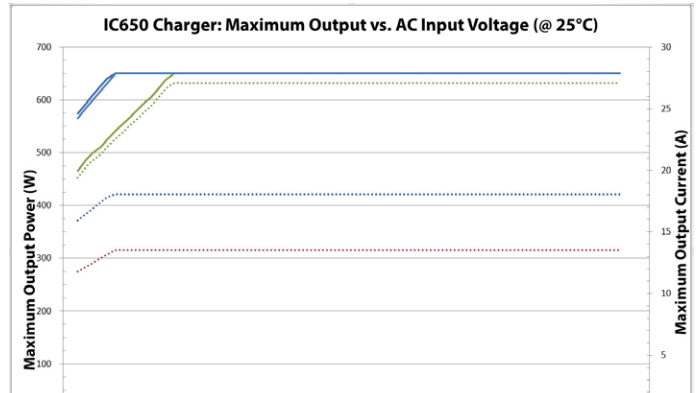

Figure 4. Output power versus AC input voltage

Power Limited

At charging voltages below 2.0 V/cell (24.0V on a 24 V charger, 36.0 V on a 36V charger, etc.), such as those found on excessively discharged or damaged battery packs, the IC650 Charger will supply its maximum DC output current at voltages as low as 0.1 V/cell. The selected charging profile may restrict this even further. While the current is limited at the charger’s maximum, the voltage is low, resulting in reduced power output.

At normal charging voltages, at and above 2.0 V/cell, the charger is capable of charging at its rated maximum power output continuously.

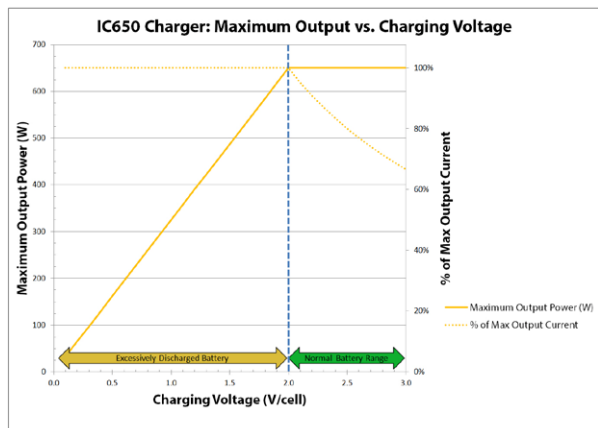
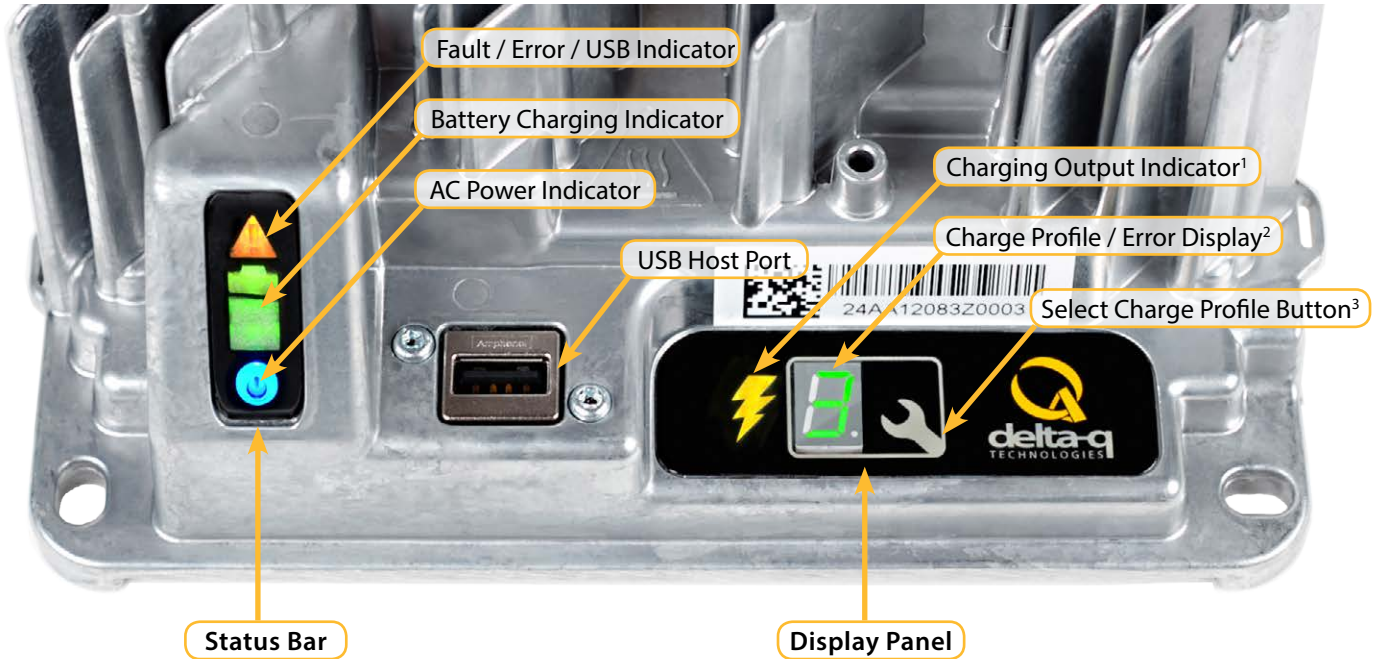

Figure 5. Maximum output power versus battery voltage per cell.

4.0 Charger Interface



	Solid red = Charger fault See display panel for details		Solid blue = AC power available
	Flashing amber = External error condition - caution See display panel for details		Flashing green = Low state of charge Solid green = High state of charge
	Flashing green = USB port active Solid green = Safe to remove USB flash drive		Flashing green = High state of charge Solid green = charge completed

1. The Charging Output Indicator is solid yellow when the charger output is active. Take appropriate actions while handling the charger, as there is a risk of electric shock.
2. The USB Host Port provides read and write USB functionality. Using a standard USB flash drive, a user can download charge tracking data, and update the charger’s software and charging profiles. See the [“USB Host Port,”](#) [“IC650 Configuration,”](#) and [“Charge Tracking Data”](#) sections for more information.
3. The Charge Profile / Error Display shows one of four possible codes to indicate different conditions:
 - ✦ ‘F’ codes mean that an internal fault condition has caused charging to stop.
 - ✦ ‘E’ codes mean that an external error condition has caused charging to stop.
 - ✦ ‘P’ codes mean that the charger programming mode is active.
 - ✦ ‘USB’ code meaning that the USB interface is active, and the USB flash drive should not be removed.

The ‘E,’ ‘F’ and ‘P’ codes are followed by three numbers and a period to indicate different conditions (e.g. E-0-0-4.). See the [“Charger Fault Codes”](#) or [“Charger Error Codes”](#) sections for details on these conditions and their solutions. ‘P’ codes indicate the charging profile number.

4. The Select Charge Profile Button is used to select a charge profile from those stored on the charger. Up to 25 charge profiles can be stored. See the [“Selecting A Charge Profile”](#) section for instructions.

4.1 USB Host Port



This is a new feature for any industrial battery charger and an original patent-pending Delta-Q innovation. The Universal Serial Bus (USB) host port on the IC650 Charger is used when configuring or retrieving data from the charger.

The USB host port accepts standard USB flash drives that are readily available at most office supply or electronic stores.

Data that is retrieved from a charger can be transferred to and viewed on a Windows-based computer running Delta-Q's IC Programmer and Data Analysis software tool.

Using the software tool, a USB Flash Drive can also be configured to program charger settings or update charger software. This enables operators to easily update charger software and/or settings, on a production line or in the field, without a custom handheld diagnostic tool or computer.

A rubber cover seals this USB port against the elements. The port itself is sealed against water and dust.

See the section "[Configuring the IC650 Charger Using a USB Flash Drive](#)" for more information.

IMPORTANT: Only directly-connected USB flash drives (single partition, FAT formatted) are compatible with the USB host port on the Delta-Q IC650 Charger. Other USB devices may not function.

4.2 Display Panel



On the right side of the charger interface is a display panel area containing three items:

1. Charging Output Indicator
2. Charge Profile / Error Display
3. Select Charge Profile Button

The Charging Output Indicator is solid yellow when the charger is outputting power. This is meant to clearly show when the charger is active, so that appropriate safety precautions can be taken if the charger is to be handled.

The Charge Profile / Error Display shows the current charge profile, or the fault or error condition the charger is currently experiencing.

The Select Charge Profile Button is pressed to view the currently active charging profile. It is also used to select a new charge profile from those loaded on the charger. See the "[Selecting a Charge Profile](#)" section for the full procedure.

5.0 Mechanical Installation

When considering installation space for the IC650 Charger, allowance for the charger's convection cooling needs are important in order to maintain maximum performance. It is also important to choose a location that allows for the following:

- + Access to the AC, DC and signal connections
- + Good visibility of the charger interface, or a pathway for the use of a remote LED on the vehicle or machine's control interface.
- + Access to the USB host port

See the "[Charger Touch Temperatures](#)" section for more information about charger temperatures and thermal images of the charger in operation.

5.1 Convection Cooling

The IC650 Charger requires sufficient airflow across its surface in order to cool the internal components. Delta-Q can assist you in fitting the IC650 Charger into your vehicle or machine to allow for enough convection airflow over the charger to maximize performance even in high ambient temperatures.

Use the following tips as a guide to ensuring the charger receives enough cooling air:

- + Allow sufficient space around the charger for cooling air to flow.
- + All orientations are possible, but mounting on a horizontal surface is best.
- + In known high ambient temperature locations ($>40^{\circ}\text{C}$), a fan may be used to direct air over the charger surface to maximize power.

Charger de-rating statistics are shown in the "[Performance Charts](#)" section.



Figure 6. Allow for some space around the IC650 Charger for convection airflow around the cooling fins.

5.2 Charger Touch Temperatures

The IC650 Charger will feel hot to the touch, especially during the bulk phase of charging. These temperatures do not pose a risk to the charger, and are a sign of the effectiveness of the heat-rejecting fins in keeping internal component temperatures low. The two hottest spots while the charger is actively charging a battery pack are on the left and right sides of the charger. In an ambient room temperature of 21°C, expected touch temperatures will range from 73°-76°C (163°-169°F). The maximum allowable touch temperature to meet safety approval requirements is 95°C (203°F).

If thermal couples are placed at the base of these peak temperature areas, well within the edge of the charger, you may measure temps that exceed 95°C. However, the charger can be expected to regulate its output to ensure any surface that can be casually touched does not exceed the 95°C limit. The temperature on the bottom of the charger should be about 8-9°C (46°-48°F) lower than the hottest temperatures on the charger sides when operating at maximum output.

Battery temperature sensors are available to be attached to the blade terminals, C1 and C2, within the DC block. The other end of the battery temperature sensor is attached to any battery post that is convenient, preferably the one that will become the hottest. Some, but not all, Delta-Q charging algorithms use temperature compensation. See the “[DC Output](#)” section for more information.

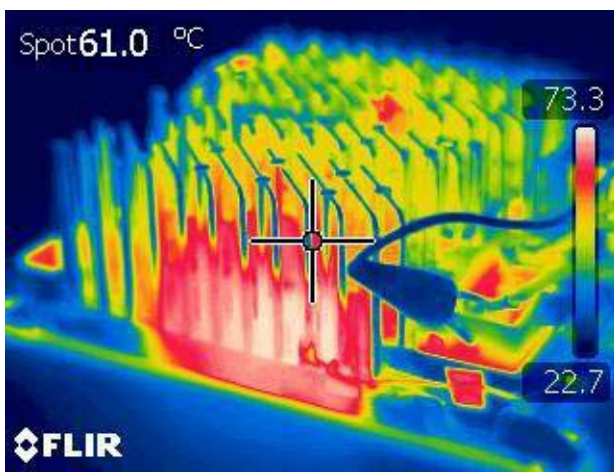

Figure 7. IC650 right side. The highest touch will temperatures occur between the cooling fins.

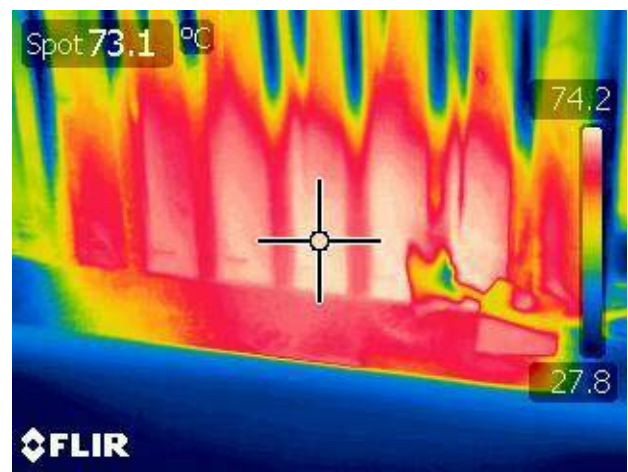

Figure 8. IC650 right side close-up. The highest measured temperature in this area is 74°C (165°F).

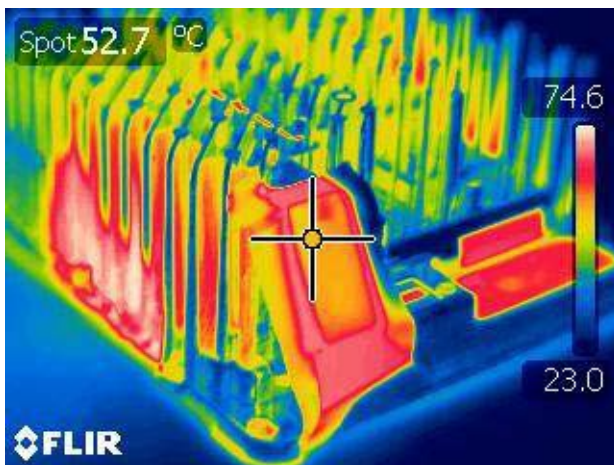

Figure 9. IC650 left side. The highest touch will temperatures occur between the cooling fins, on the left side of this picture.



Figure 10. IC650 left side. The highest measured temperature in this area is 77°C (170°F).

5.3 Mounting Points

Robust mounting lugs are cast into the IC650 Charger's die cast aluminum enclosure. In each corner are 6.3mm (1/4") diameter slots, arranged to allow ample tolerance when mating with standoffs or predrilled holes in a machine. In addition, a keyhole slot has been provided to in the back of the charger so it can be hung vertically on a wall or secured to a shelf.

If mounting the charger on a vehicle frame that may be prone to flexing, it is recommended to mount the charger using only three of the mounting points to prevent the charger case and internal components from being subjected to undue stress and torsional loads.

- ✦ Mount the charger securely using the mounting points shown in Figure 11.
- ✦ In some cases, a bracket may need to be fabricated, particularly if there is insufficient cooling air flow.
- ✦ Do not drill holes in the unit for mounting.

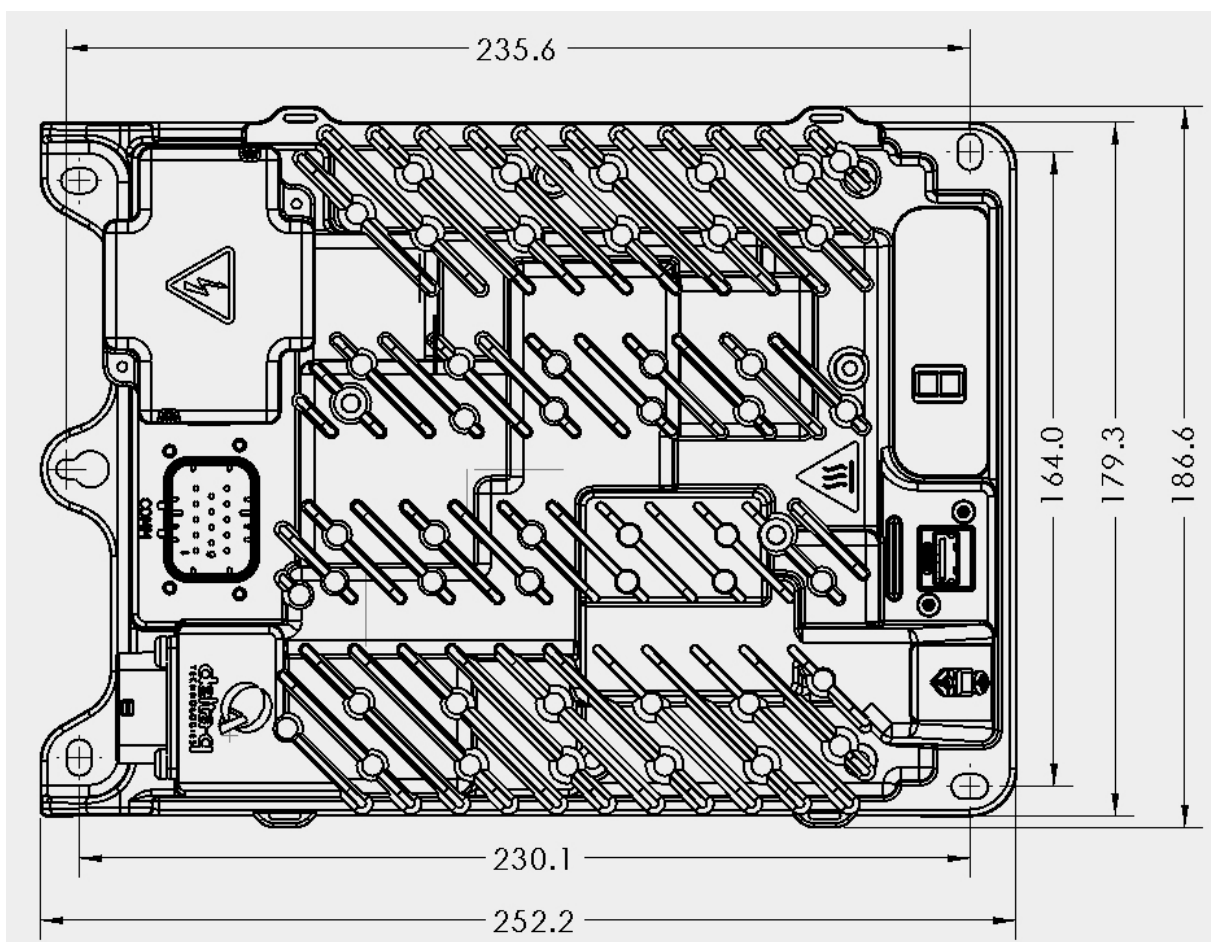

Figure 11. Charger Mounting Points

5.4 Cable Dressing

It is recommended that AC, DC and signal cables be secured, especially in applications where there are high vibration and shock loads. To facilitate doing so, mounting points have been cast-in to each side of the charger enclosure to provide places to attach cable ties.

6.0 Electrical Installation

The IC650 Charger has either two or three connectors on the rear panel depending on its configuration. The Comm model with all connectors is shown in Figure 11. The Base model does not have a Comm connector, but “Comm” will still be visible on the charger because of the enclosure casting process.

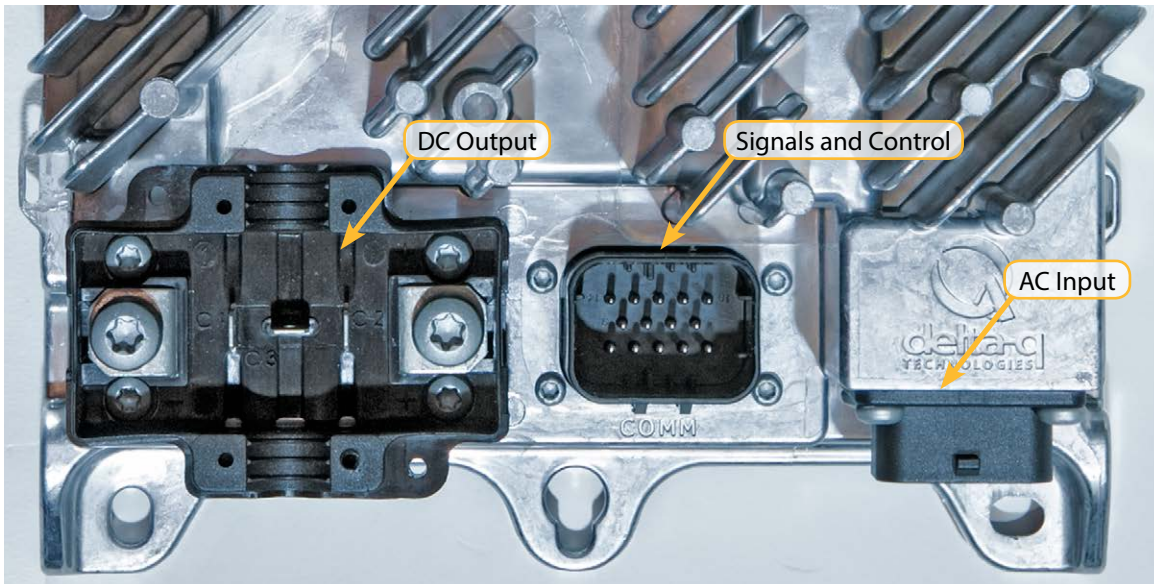

Figure 12. IC650 Comm model rear panel

6.1 AC Input

Connector Type: Standard IEC320/C14

Mating Connector: Standard IEC-60320-C13

The AC cord can be supplied by Delta-Q or standard IEC cords can be sourced directly from a cord manufacturer or electronics distributor (e.g. Mouser, Digi-Key).

For industrial applications where the AC cord may be exposed to hard usage and moisture, Delta-Q recommends that the cord is UL listed with an SJTW (or SJT) rating, 105°C (221°F), 300 V rating (or equivalent).

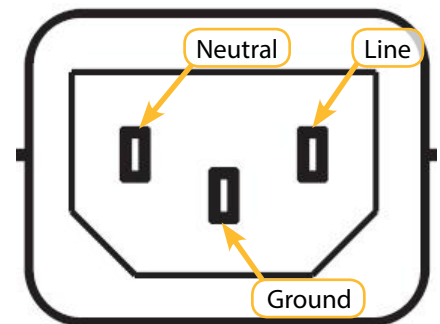

Figure 13.AC Input Connector

To prevent the AC cord from working loose, secure it to the charger enclosure using cable ties.

Connector Pin Configuration

Pin No.	Wire Color Code	Recommended Wire Diameter	Description	Notes
L	Brown	18AWG / 1.0mm ²	AC Line	Use an extension cord rated for at least 6A at 110VAC and 3A at 220VAC. Do not use a light-duty indoor extension cord.
G	Green / yellow		AC Ground	
N	Blue		AC Neutral	

6.2 Signals and Control

Connector type: TE Connectivity AmpSeal 776262

Mating connector: TE Connectivity AmpSeal 776273-x series

This is a heavy-duty, automotive-grade, waterproof signal connection system. When assembling, care must be taken to ensure all unused signals (i.e. those without a wire) are properly blocked with the appropriate part. When assembled properly, it will provide a long service life.

Note: Pin numbers 1, 5, 6, 9, 10, and 14 are labeled on the connector. These numbers are upside-down when the connector is viewed from the back of the charger.

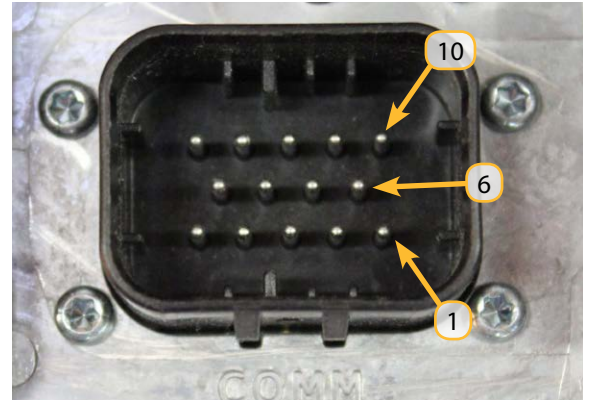

Figure 14. Signals and control connector

Pin No.	Recommended Wire Size (AWG / mm ²)	Description	Detail
1	16-20 / 1.3-0.52	CAN-GND	Reference ground for CAN signals
2		Interlock 1 (NC)	Interlock relay: Normally closed contact
3		Interlock 2 (COM)	Interlock relay: Common contact. Recommend inline 0.5A fast-blow fuse
4		Interlock 3 (NO)	Interlock relay: Normally open contact
5		Battery Temp. Sense '+'	Connect to NTC 10k 5% thermistor
6		CAN High	See Communications section
7		Battery Negative	Reference ground for battery signals
8		Enable / Disable	Use for single-wire BMS control. See Communications section.
9		LIN bus	See Communications section.
10		CAN Low	See Communications section.
11		Comm Port	Service use only.
12		LED Positive (+)	For remote LED anode
13		LED Negative (-)	For remote LED cathode
14		Battery Temp. Sense Ground	Reference ground for battery temperature sensor signal

6.3 DC Output

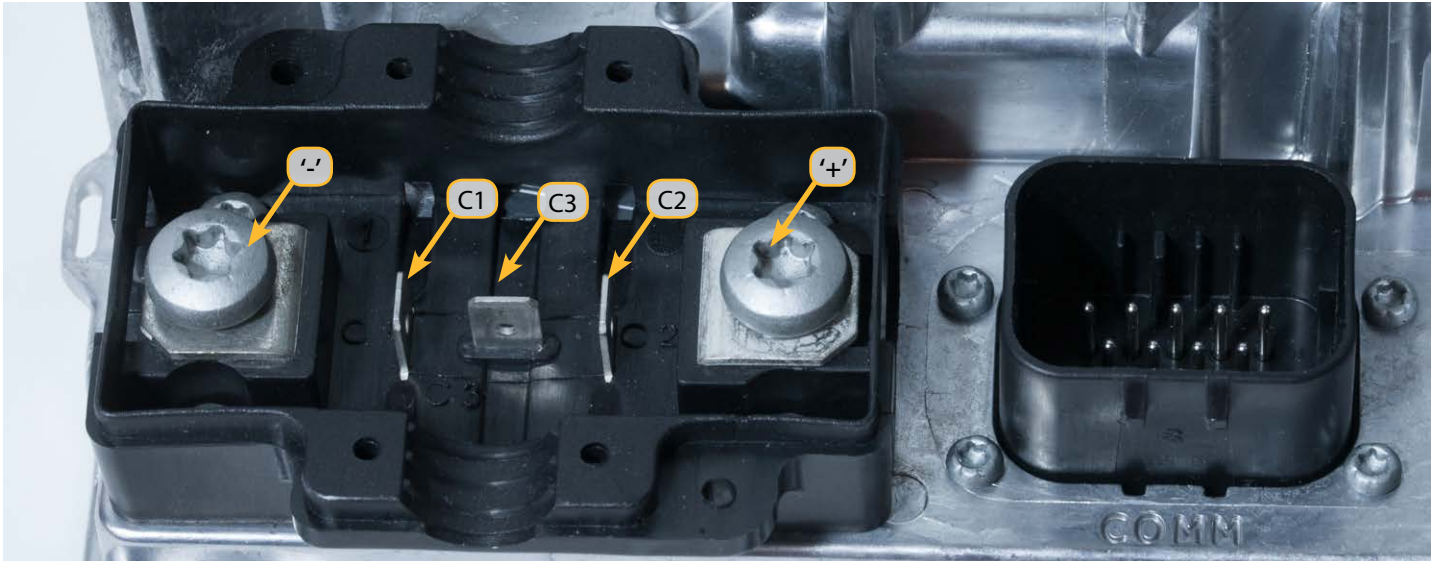

Figure 15. DC output terminals

The DC Terminal block is designed to allow a DC cable to be attached leading to the front or to the back of the charger. A DC cable clamp secures the DC cord to the terminal block using two Torx T10 screws. The DC cable clamp is designed to provide optimum compression for cable diameters in the 9mm to 11mm range. Care must be taken to prevent overtightening these screws during assembly. **The recommended torque for the DC cable clamp is 0.6Nm +/-6%.**

A DC Terminal Block Cover is provided to protect the user from casual contact with the DC terminals. After final connections are made to the terminals, the cover is snapped into place and secured with one screw.

WARNING: Be very careful not to allow the battery voltage to be accidentally applied to the blade terminals, as permanent damage to the charger will result.

Pin Configuration

Pin	Recommended Wire Size (AWG / mm ²)	Description	Notes
'-'	12 / 3.0	Battery negative	Accepts 1/4" or larger ring terminal Torx T30 / M6 bolts Recommended torque: 4.5N-m +/-5%
'+'	12 / 3.0	Battery positive	
C1	20 / 0.5	Battery temperature sense negative	1/4" blade terminal; connected internally to battery negative
C2	20 / 0.5	Battery temperature sense positive	1/4" blade terminal
C3	20 / 0.5	Interlock	1/4" blade terminal; normally closed to battery positive. Open when charger output may be active.

6.4 AC and DC Cabling Instructions

AC and DC cabling for the IC650 Charger can be completely customized by the customer. Cables can easily be attached into the sealed DC block and the IEC320 AC receptacle.

The modular design of the IC650 Charger has several benefits:

- + Customers only have to manage a single SKU for each power level (e.g. 24V / 36V / 48V).
- + Units can be customized by the customer at their factory based on demand for specific DC connectors or AC cords for different countries.
- + AC and DC cables are field replaceable, saving the time and expense of sending units for repair. When supplied with cables, field technicians can test and operate the charger in only a few minutes.

DC Cabling Installation Instructions

To attach DC cabling to the IC650 Charger, you will need the following items:

- + 1 - Torx T30 screwdriver
- + 1 - Torx T10 screwdriver
- + 2 - Torx T30 / M6 screws
- + 2 - Torx T10 screws
- + 1 - DC cable with ring terminals for attachment into the DC block
- + 1 - Delta-Q IC650 DC block cover (part no. _____)
- + 1 - Delta-Q IC650 DC cable clamp (part no. _____)

1. Remove the DC block cover.

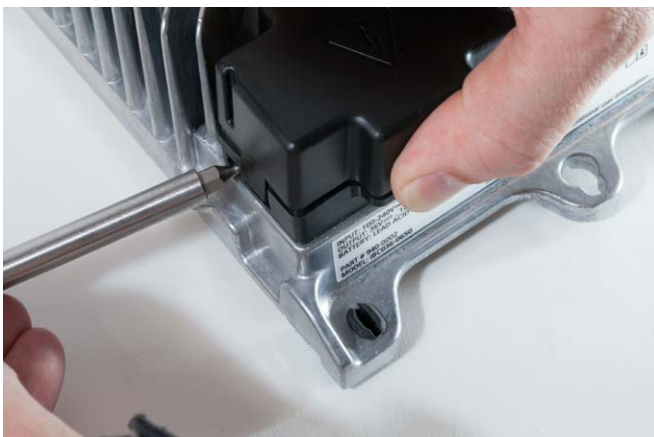

Figure 16. Remove the DC block cover by inserting the head of the Torx T30 screwdriver into the gap on the lower left side of the DC block fixture, and apply pressure to trigger the cover's release. It can be removed and put aside.

2. Attach the DC cable clamp over the DC cable, then attach positive and negative leads from the DC cable to the positive and negative terminals inside the DC block. Reattach the DC block cover.

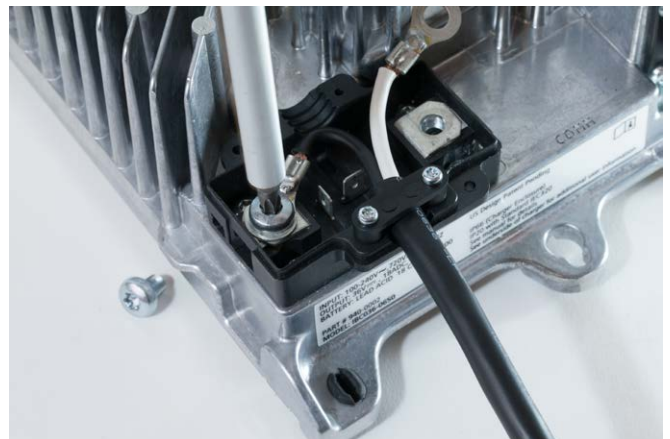

Figure 17. Fix the DC cable in place using the Delta-Q cable clamp, fastened with Torx T10 screws to a recommended torque of 0.6Nm +/-6%. Proceed by attaching the positive and negative leads to the positive and negative terminals, respectively, using the Torx T30 screwdriver and Torx T30 / M6 screws, with a recommended torque of 4.5Nm +/-5%.



6.4 AC and DC Cabling Instructions

AC Cabling Installation Instructions

The IC650 Charger allows any country-specific IEC320/C14 AC cable to be used with the charger's standard IEC-60320-C13 mating connector. This allows an OEM to source AC cables depending on demand in different countries.

For industrial applications where the AC cord may be exposed to hard usage and moisture, Delta-Q recommends that the cord is UL listed with an SJTW (or SJT) rating, 105°C (221°F), 300 V rating (or equivalent).

No tools are required for installation, although it is recommended that cable ties be used to securely fasten the AC cable to the charger.



Figure 18. Both the DC and AC cabling has been installed on this IC650 Charger. Using cable ties with the AC cabling is recommended, as these cables may be pulled out of the mating connector.

6.5 IC650 Communications Cabling Instructions

This section only applies to the Comm model IC650 Charger. No tools are required to install the TE Connectivity AmpSeal Plug assembly (Part number 776273) into the Comm fixture on the IC650 Charger. See the [Communication section](#) for more information about communications capabilities.



Figure 19. TE Connectivity AmpSeal Plug assembly (Part no. 776273) for onboard communication capabilities, including CAN bus and Modbus.



Figure 20. Insert the TE Connectivity AmpSeal Plug into the Comm fixture with the locking mechanism facing toward the outer edge of the charger.



Figure 21. Apply pressure until you hear an audible “click” as the plug locks into position.

6.6 Remote LED

The remote LED recommended for use with the IC650 Charger's LED outputs is Delta-Q part number 900-0058 - "Remote LED 3m shielded bare wires."



Figure 23. Sample of a 3 metre LED (Part 900-0058)

Part Type	Recommended Provider / Part Number
Recommended remote LED	Lite-On LTL-293SJW or similar 2.0V bi-color LED, 5mm T1-3/4
Recommended LED holders	Lumex SSH-LX5091 and SSH-LX5090 or similar (maximum 1.5mm panel) Bivar CR-174L for 1.5 - 6.4 mm panel Bivar CR174 for 0.8-3.2 mm panel
Cable	22AWG (0.5mm ²) 2-conductor with shield grounded to chassis
Maximum length	7.5m (25') using 22AWG wire

The following items may also be used with the remote LED connections on the IC650 Charger:

Operation

LED polarity:

LED '+' is red cathode / green anode (white wire)

LED '-' is green cathode / red anode (black wire)

LED signal operation:

Green: LED '-' line low 0%, LED '+' line 1kHz at 90% duty cycle

Red: LED '-' line 1kHz at 90% duty cycle, LED '+' line low 0%

Yellow: Both lines 1kHz at 92% duty (one line inverted from the other so one is low for 92%, while the other is high for the same time).

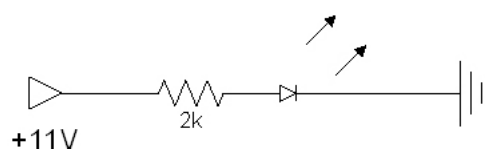

Figure 22. Simplified internal schematic of remote LED. I: 4.5mA / V_L: 2.0V

6.7 Interlock Relay Contacts

The Comm model has three pins marked as “NC, NO, and COM”. These are “dry” contacts of an internal interlock relay. The term “dry” means there is no power on any of these contacts. The relay itself is driven when AC Voltage to the charger is in range. For example, when there is AC voltage, the COM and NO pins will be shorted. Refer to the figure below for the internal schematic of these pins.

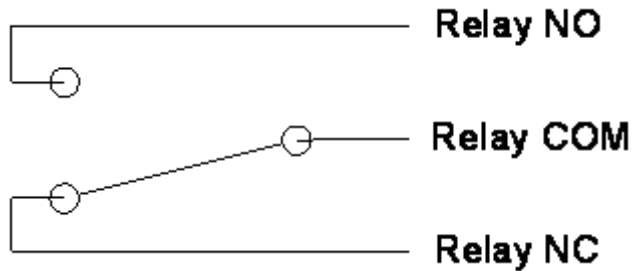

Figure 24. Internal schematic of interlock relay contacts.

It is recommended that the interlock circuit on Delta-Q’s IC650-COMM model is protected by a Fast-Blo fuse with a current rating of 0.5 A (or less), >100 VDC rating, using any typical “in-line” package and holder.

Examples include:

- ✦ 0.25” x 1.25” 3AG and 5 mm x 20 mm M205 glass/ceramic cartridge types.
- ✦ Auto style blade fuses (e.g. ATC-1) may also be an option, though most are rated at only 32 VDC and may not be suitable for your application.

While a 1A fuse may be used in some cases, the 0.5A rating is well within the limits of the relay’s contacts, the PCB traces and the in-line RF/EMI-filtering ferrites.

Delta-Q may use either an Omron (G6S-2F-DC12) or Panasonic (TX2SA-12V) part for the interlock relay. Worst-case contact specifications are listed below the respective figures for your reference

1. Maximum switching capacity

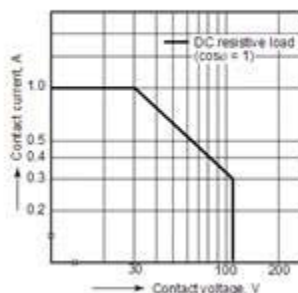

Figure 25. Panasonic TX2SA-12V
1 A @ 30 VDC
30 W (no VA rating available)
Contact resistance: <100 mΩ

Maximum Switching Capacity

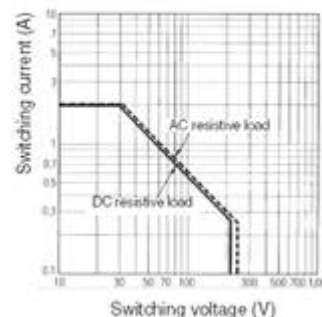

Figure 26. Omron G6S-2F-DC12
0.5 A @ 125 VAC
62.5 VA
Contact resistance: <75 mΩ

7.0 Communications

The Comm version of the IC650 Charger supports advanced functions accessible via the CAN interface. Details for CAN bus will be updated by August 2013.

8.0 IC650 Configuration

There are two ways to alter the configuration on the IC650 Charger:

1. Use the Select Charge Profile Button.
2. Use a pre-programmed USB flash drive.

8.1 Selecting A Charge Profile Using the 'Select Charge Profile Button'

1. Disconnect AC input from the charger, or from the wall outlet. Wait 30 seconds for the input relay to open.
3. Press and release the Select Charge Profile Button to advance through charging profiles loaded on the charger. The selected charging profile will be displayed up to three times (e.g. "P-0-1-1" for Profile 11).*



Figure 28. Disconnect AC input from the charger.

2. While reconnecting AC input, press and hold the Select Charge Profile Button. Hold the button until Error Indicator is on and Battery Charging Indicator starts flashing.



Figure 29. Reconnect AC input while holding the Select Charge Profile Button.



Figure 27. Press the Select Charge Profile Button to advance through the charge profiles. When the desired charge profile appears, hold the button for 10 seconds to confirm your selection.

*Process will time out and profile will remain unchanged if there is 15 seconds of inactivity, a profile number is allowed to display three times, or if AC power is cycled.

4. Once the desired charging profile is displayed, press and hold the button for 10 seconds (see Figure 3) to confirm selection and exit Profile Selection Mode.
5. Press the Select Charge Profile Button to check that the desired profile is selected.

8.2 Configuring the IC650 Charger Using a USB Flash Drive

Using the Delta-Q software, USB storage drives can be pre-programmed to certain charger configurations. To use the USB port, follow these steps:

1. Insert the USB flash drive at any time, except during a charge cycle. Stop the charge cycle by removing AC power or the DC connection to the batteries. The charger will power the USB port from the remaining AC connection.
2. If there is enough disk space, the charger will write charge tracking data to the drive. The Fault / Error / USB Indicator will flash green during reading and writing.
3. If the drive contains compatible configuration files, the charger will load them.
4. The IC650 Charger will briefly reset.
5. Remove the drive when the Fault / Error / USB indicator is solid green.



Figure 30. Insert the USB flash drive to begin the reprogramming process. When complete, the Fault / Error / USB indicator will be solid green as shown.

Troubleshooting

If the alarm indicator flashes amber, note the error code and retry the update. If there is no response to inserting the USB drive when the charger is being used off-board, check that AC power is available and connected. If the charger is installed on-board, ensure that the charger either has AC power and / or batteries are connected.

Confirming a Software Update

After using a USB flash drive to update the charger firmware, the update can be confirmed by reviewing the .txt file written to the flash drive by the charger. It will be located in the folder labelled 'syslog' (e.g. F:\CHARGER\RESP\serialno\syslog\00000000.txt).

Open this file using a text editing program such as Notepad or Microsoft Word. If the update has been successful, near the end of the text you will see a description resembling "SM Task: Successful upgrade at Major[001].Minor[001].Build[000] variant[008]."

Alternatively, if you are using the IC Programmer and Data Analysis Tool, you will be able to see which software and charging algorithm used for each charge cycle in the Charger Cycle Summaries.

9.0 Troubleshooting

The IC650 Charger is continuously monitoring itself and its environment for unusual conditions. There are a few indications that may require the user's attention.

Symptom	Recommended Action
No indicator lights	Check AC power and connection to batteries
Flashing red Fault / Error / USB Indicator	Read fault code (e.g. F-0-0-1) number on the Charge Profile / Error Display and refer to the fault code table below
Flashing amber Fault / Error / USB Indicator	Read error code (e.g. E-0-0-1) number on the Charge Profile / Error Display and refer to the error code table below

9.1 Charger Fault Codes

Code	Description	Solution
F-0-0-1	DC-DC failure: LLC excessive leakage fault	Internal charger fault. Remove AC and battery for minimum 30 seconds and retry charger. If it fails again, return to Delta-Q for root cause analysis.
F-0-0-2	PFC failure: PFC excessive leakage fault	
F-0-0-3	PFC has taken too long to boost	
F-0-0-4	The charger has been unable to calibrate the current offset.	
F-0-0-6	Circuit failure: Internal sensors out of range	

9.2 Charger Error Codes

Code	Description	Solution
E-0-0-1 E-0-2-1	Battery high voltage	Check the battery voltage and cable connections. Check battery size and condition. This error will automatically clear once the condition has been corrected.
E-0-0-2 E-0-2-2	Battery low voltage	Check the battery voltage and cable connections. Check battery size and condition. This error will automatically clear once the condition has been corrected.
E-0-0-3	Charge timeout caused by battery pack not reaching required voltage within safe time limit.	Possible causes: Charger output reduced due to high temperatures, poor battery health, very deeply discharged battery and /or poorly connected battery. Possible solutions: Operate at lower ambient temperature. Replace battery pack. Check DC connections. This error will automatically clear once the charger is reset by cycling DC.
E-0-0-4	Battery could not meet minimum voltage	Check for shorted or damaged cells. Replace battery pack. Check DC connections. This error will automatically clear once the charger is reset by cycling DC.
E-0-0-5	Charger temperature limit exceeded	Ensure sufficient cooling air flow and reset charger (disconnect DC or AC for 10 minutes then reconnect). This error will automatically clear once the condition has been corrected.
E-0-0-6	Low AC voltage error	Connect charger to an AC source that provides stable AC between 85 - 270 VAC / 45-65 Hz. This error will automatically clear once the condition has been corrected.
E-0-0-7	Battery amp hour limit exceeded	Possible causes include poor battery health, very deeply discharged battery, poorly connected battery, and / or high parasitic loads on battery while charging. Possible solutions: Replace battery pack. Check DC connections. Disconnect parasitic loads. This error will automatically clear once the charger is reset by cycling DC.
E-0-0-8	Battery temperature is out of range	Possible battery temperature sensor error. Check temperature sensor and connections. Reset charger. This error will automatically clear once the condition has been corrected.
E-0-1-2	Reverse polarity error	Battery is connected to the charger incorrectly. Check the battery connections. This error will automatically clear once the condition has been corrected.
E-0-1-6 E-0-1-8 E-0-2-6	USB operation failed	Software upgrade failure or script operation failure. Ensure the USB flash drive is properly formatted and retry inserting the USB flash drive into the charger.
E-0-2-3	High AC voltage error (>270VAC)	Connect charger to an AC source that provides stable AC between 85 - 270 VAC / 45-65 Hz. This error will automatically clear once the condition has been corrected.
E-0-2-4	Charger failed to initialize	The charger has failed to turn on properly. Disconnect AC input and battery for 30 seconds before retrying.
E-0-2-5	Low AC voltage oscillation error	AC source is unstable. Could be caused by undersized generator and /or severely undersized input cables. Connect charger to an AC source that provides stable AC between 85 - 270 VAC / 45-65 Hz. This error will automatically clear once the condition has been corrected.

9.3 Charge Tracking Data

All IC650 Chargers record data such as amp hours returned, charge cycle completion or interruption, and the charge profile being used. This data can be very useful in vehicle or machine diagnostics, and can be viewed using the IC650 Programmer and Data Analysis Tool, available from Delta-Q.

To retrieve this data, follow these steps:

1. After a charge cycle is complete, or the charger is disconnected from the battery pack, insert a USB flash drive with at least 2MB of free space into the IC650 Charger's USB host port. The charger will automatically begin to download the data, shown on the Fault / Error / USB Indicator with a flashing green light.

If you plan to download data from a large number of chargers, having more free space on your USB flash drive is recommended. If you want to update the software on only some of your chargers, it is recommended that you use separate USB flash drives for updating and downloading charge tracking data.



Figure 31. Insert the USB flash drive to begin the charge data download process. This step can be completed using the same USB flash drive programmed to update the charger's software. The process is completed when the USB indicator is solid green, and no longer flashing.

2. The downloading process is complete when the Fault / Error / USB Indicator is solid green. The USB flash drive can be removed from the charger.



Delta-Q IC650

650W Industrial Battery Charger

Key Features	Benefits
Rugged, sealed aluminum die cast enclosure	<ul style="list-style-type: none"> + Protected against high vibration, extreme temperatures and water, chemical and dust ingress + Installable on- or off-board in any orientation
Two-way communication through charger USB host port	<ul style="list-style-type: none"> + USB flash drive retrieves detailed charging logs and updates charger software and QuiQ charge profiles + Saves technician field visits by providing info for battery maintenance or troubleshooting
Wide AC input voltage range, high efficiency and unity power factor	<ul style="list-style-type: none"> + Operates on any single-phase grid worldwide + Meets CEC energy efficiency standards + Reduced electricity costs
QuiQ™ optimized charging profiles for all popular industrial battery brands and types	<ul style="list-style-type: none"> + Extend battery life and minimize charge times + Auto-recharge for low voltage / storage ensures equipment is ready for use
CAN bus and Modbus communication	<ul style="list-style-type: none"> + Integrate charger with battery management system and vehicle / machine electronics

IC650 Specifications



Features

- + Multi-color LED indicator for AC source, battery status (<80% / >80% / completion), charging, alarm, fault
- + Numeric display for charge profile, alarm / fault codes
- + Field programmable with up to 25 QuiQ™ charge profiles
- + OEM customizable, field replaceable cable design

Dimensions

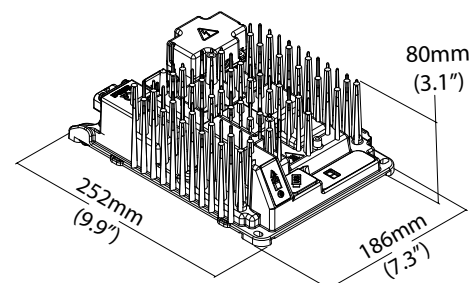

DC Output	24 VDC	36 VDC	48 VDC
Nominal DC output voltage	24 V	36 V	48 V
Maximum DC output voltage	36 V	54 V	72 V
Maximum DC output current	27.1 A	18.1 A	13.5 A
Maximum DC output power	650 W	650 W	650 W
Deep discharge recovery (minimum voltage)	1.2 V	1.8 V	2.4 V
Maximum interlock current	1 A	1 A	1 A
Ripple	Voltage ripple < 0.5%p-p		Current ripple < 2.5%p-p
Battery type	Lead acid (Wet / AGM / GEL), lithium Ion		
Reverse polarity	Electronic protection with auto-reset		
Short circuit	Electronic current limit		

AC Input		
AC input voltage range	85-270 VAC	
Nominal AC input voltage	100-240 VAC	
Nominal AC input frequency	50 / 60 Hz	
Maximum AC input current	7.5 A	
Nominal AC input current	7.3 A @ 100 VAC	6.0 A @ 120 VAC
	3.1 A @ 230 VAC	2.9 A @ 240 VAC
Nominal AC power factor	>0.99 @ 120 VAC	>0.98 @ 230 VAC
Power Conversion Efficiency	90.7% at full load (120 VAC, 48 VDC)	93.5% at full load (240 VAC, 48 VDC)

Regulatory	
Safety	Approval pending to UL1564, CSA 107.2, EN 60335-2-29, AS/NZS60335
Emissions	FCC Part 15 / ICES 003 Class A, EN55011
Immunity	EN61000-3-2, EN61000-3-3, EN 61000-4-2/-3/-4/-5/-6/-11
Environmental	ROHS and REACH compliant
Efficiency	Meets California Energy Commission (CEC) energy efficiency standards for battery charging systems

Environmental		
Operating temperature	-40°C to +65°C (-40°F to 149°F)	Derated at >40°C (104°F)
Storage temperature	-40°C to +85°C (-40°F to 185°F)	
Ingress Protection	IP66 (Complete protection against contact, dust, and powerful water jets) with Delta-Q supplied AC cord	
Chemical	MIL 810-G, Method 504.1: Withstands exposure to chemicals typically found in application (battery acid, salt, cleaners, fertilizers, etc.)	
Salt	Withstands 720 hours (30 days) salt spray test per GMW 3172 with 5% (w/w) salt solution (pH 6.5-7.2) at 35°C (95°F) without degradation of performance	
Shock / Vibration	Infrequent shock: 100g, 11 ms half-sine pulse, 3 cycles in each of 3 axes Repetitive shock (bump): 25g, 11 ms, 2400 cycles Vibration: Random vibration of 4.55g from 10-1000Hz for 8 hours in each of 3 axes, using the sprung mass profile of GMW 3172	
Humidity	0 to 95% non-condensing	
Altitude	< 15,000 feet derated above 20°C	

IC650 Specifications

Mechanical		
Dimensions	Charger: 25.2 x 18.6 x 8.0 cm (9.9 x 7.3 x 3.1")	
	Shipping carton: 32.5 x 30.5 x 12.0 cm (12.8 x 12.0 x 4.5")	
Weight	Charger: 2.4 kg (5.3 lbs)	
	Shipping carton: 3.0 kg (6.6 lbs)	
AC input connector	IEC320 / C14 (requires country-specific cord)	
DC output connector	M6 threaded fasteners for ring terminals, field replaceable in the event of cross-threading or other damage	
Signal Connector	IC650 BASE	IC650 COMM
	6.3 mm (1/4") blade terminals: C1 - Battery temp. sense '-' C2 - Battery temp. sense '+' C3 - Interlock signal	6.3 mm (1/4") blade terminals: C1 - Battery temp. sense '-' C2 - Battery temp. sense '+' C3 - Interlock signal TE AmpSeal automotive connector (IP67 rated) mates with TE Connectivity AmpSeal Plug (p/n: 776273): Signals for CAN bus (isolated); Remote status indicators; Battery temperature sense; Interlock; Enable / disable; Modbus
Service port	Sealed (IP66) USB 2.0 Host Port (Type A) with dust cover	
Mounting holes	6.3 mm (1/4") diameter slots in each corner for safe installation on shelf, wall or bulkhead	
Cooling	Normal operation in any orientation with passive cooling only	

Operation			
Status indicators	AC present, charging status (low state-of-charge, high state-of-charge, complete), alarm, fault, USB activity		
Numeric display	Displays selected charging profile, alarm and / or fault codes		
Long-term storage mode	Automatic restart to maintain battery state-of-charge and prevent sulphation or freezing		
Power source	Charge control circuitry powered from AC input. Backup power provided by battery if AC not present.		
Standby AC power consumption	2.40 W		
Quiescent DC current (connected to battery only)	24 VDC	36 VDC	48 VDC
	27 mA (0.65 W)	18 mA (0.65 W)	15 mA (0.72 W)

USB Host Port	
Required equipment	Standard USB flash drive with FAT formatting
Charge Tracking Data Points	VAC, IAC, VDC, IDC, temperature (battery & charger) Ahr returned, charge duration, end of charge voltage, fault / error codes logged
Software Update	Allows updating of software using USB flash drive, replacing software and / or charge profiles

Communications / Signals	IC650 BASE	IC650 COMM
Battery temperature input	Isolated temperature sensor signals (mates with Delta-Q isolated battery temperature sensors)	
Charge enable / disable input	Not available	PWM signal
Interlock signal	Standard (Battery positive signal when AC not present)	NO or NC (selectable) dry contact 0.5 A fast-blow fuse (>100 VDC rated) required
Remote status indicator	Not available	Tri-color red / yellow / green
CANbus	Not available	Isolated CAN-H, CAN-L, CAN-GND CANopen CiA 418: Battery and CiA 419: charger CANopen CiA 454: Light electrical vehicles (LEV)
Serial communications	Not available	Modbus RTU

IC650 Specifications

Special Features

Charging profile selection	Up to 25 charging profiles stored on the charger. Button and LED numeric display allows default charging profile to be selected.
Datalogging	Flash memory for logging charge cycle parameters (V, I, T, Ah returned, charge duration), events and diagnostic information.
Service	No custom service tools needed. USB flash drive used to update charger software, load charging profiles, select default charge profile and download charge tracking and diagnostic information.
External communications	PC-based configuration software for field programmability.

Options

OEM-specific AC, DC & signal cords	Customized cords to suit OEM requirement, factory-installed for OEM convenience		
AC cord	p/n 900-0063: 2m (6.5') 14AWG IEC320-NEMA5/15		
Isolated battery temperature sensor	p/n 900-0056 3m (9.8') bare wires	p/n 900-0059 0.14m (5.5") bare wires	p/n 900-0060 1.2m (47.2") bare wires
Tri-color remote status indicator	p/n 900-0058: Remote LED, 3m (9.8') shielded bare wires, tri-color red / yellow / green		
IC series handle & rubber feet kit	p/n 900-0111: Handle, rubber feet and associated mounting hardware		

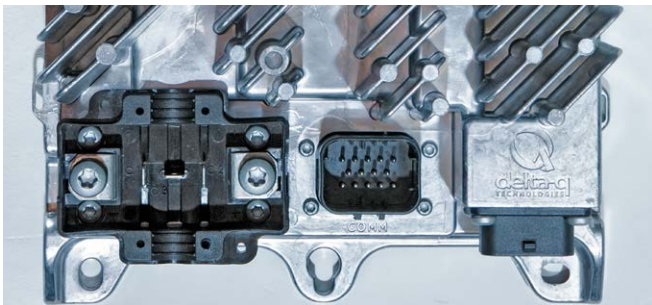

IC650 COMM (Rear View)

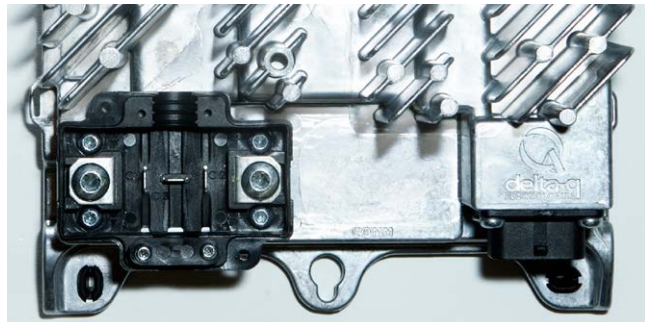

IC650 BASE (Rear View)

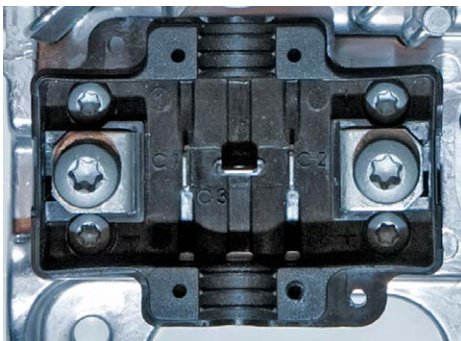

Close-up view of battery temperature sense and interlock blade terminals within DC output block.

10.2 Performance Charts

These charts indicate typical performance, dependent on the application.

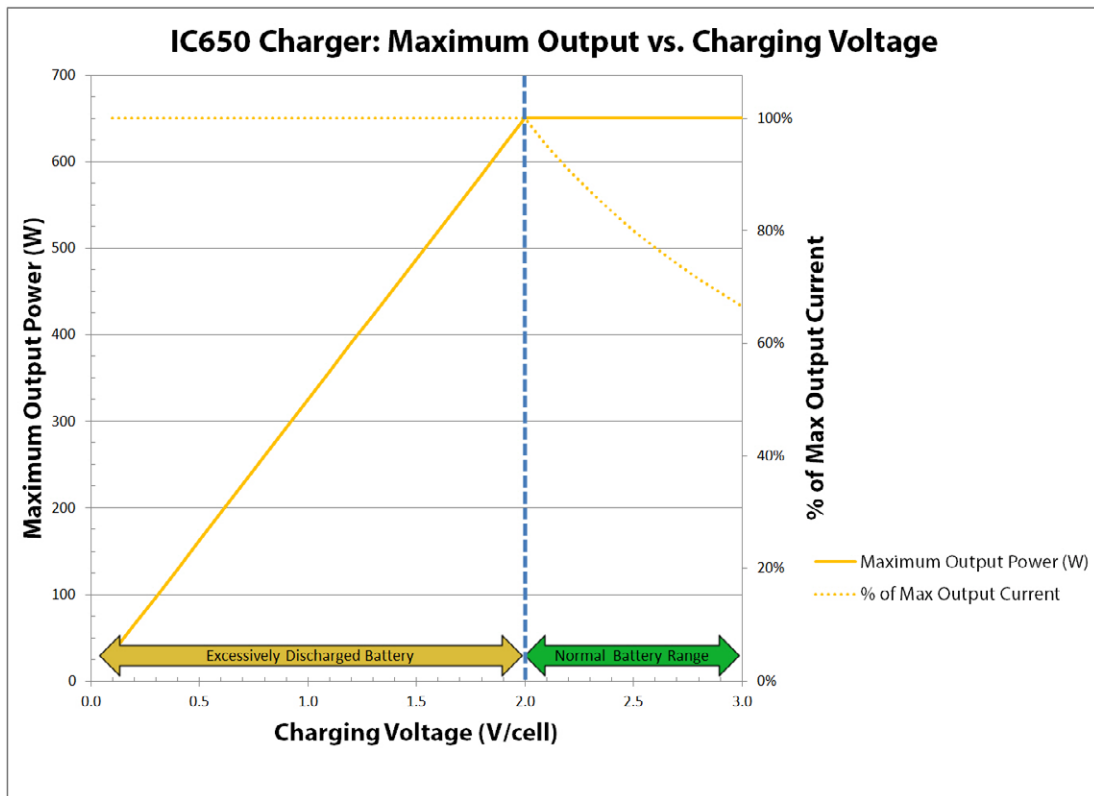
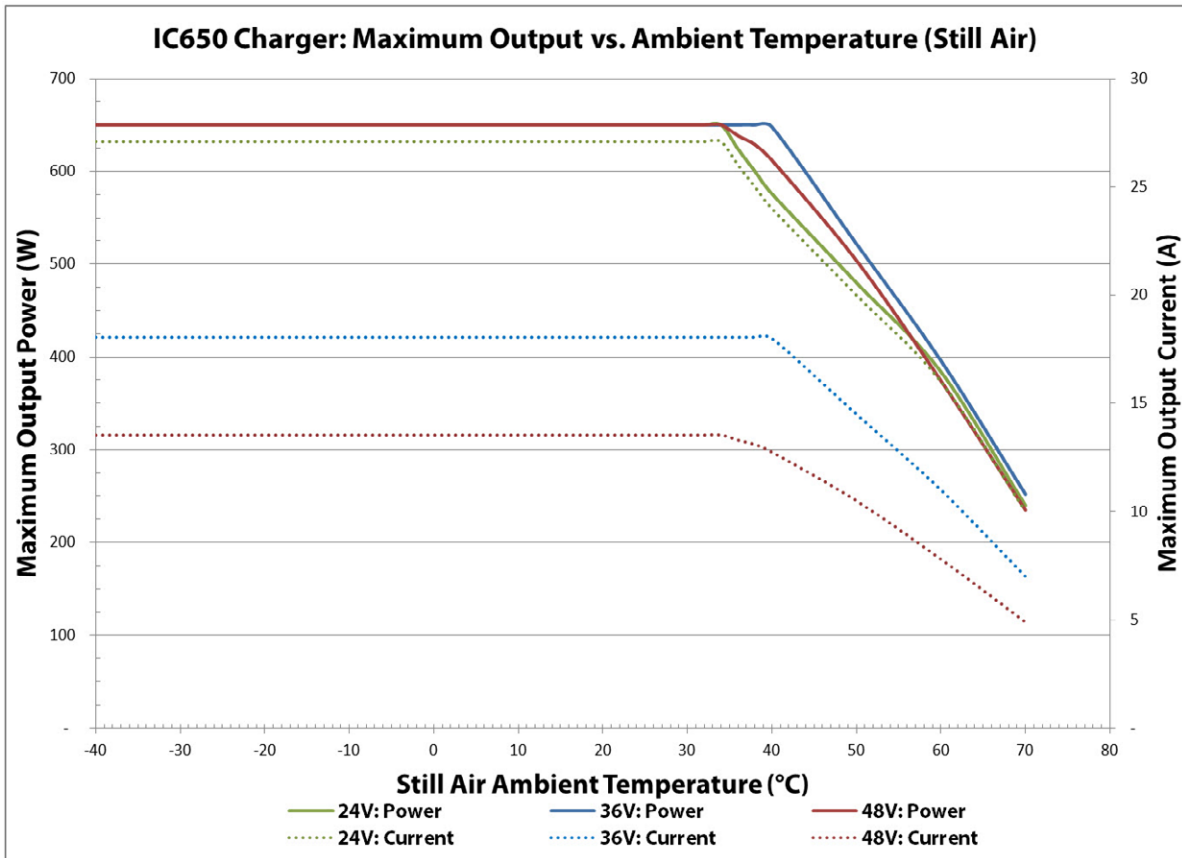

10.2 Performance Charts

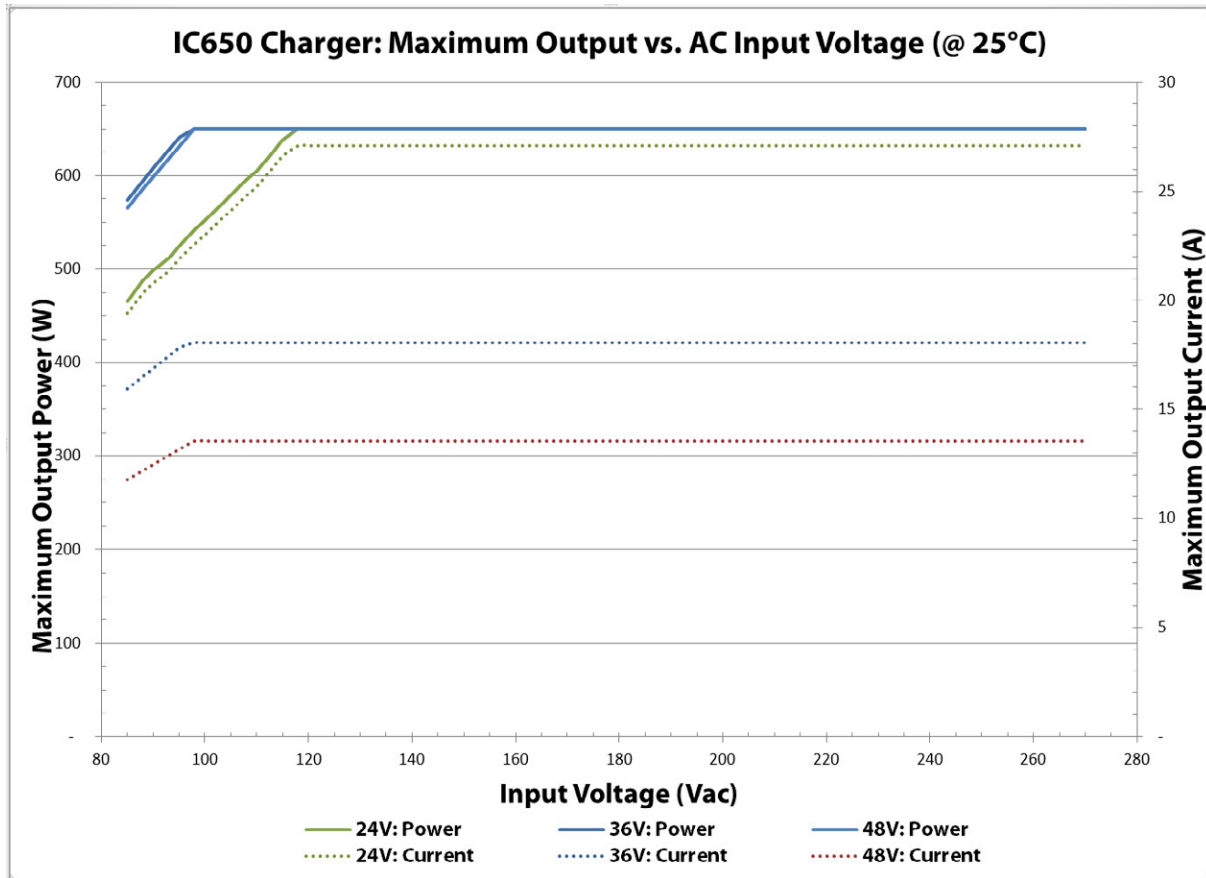

10.3 Product Drawings

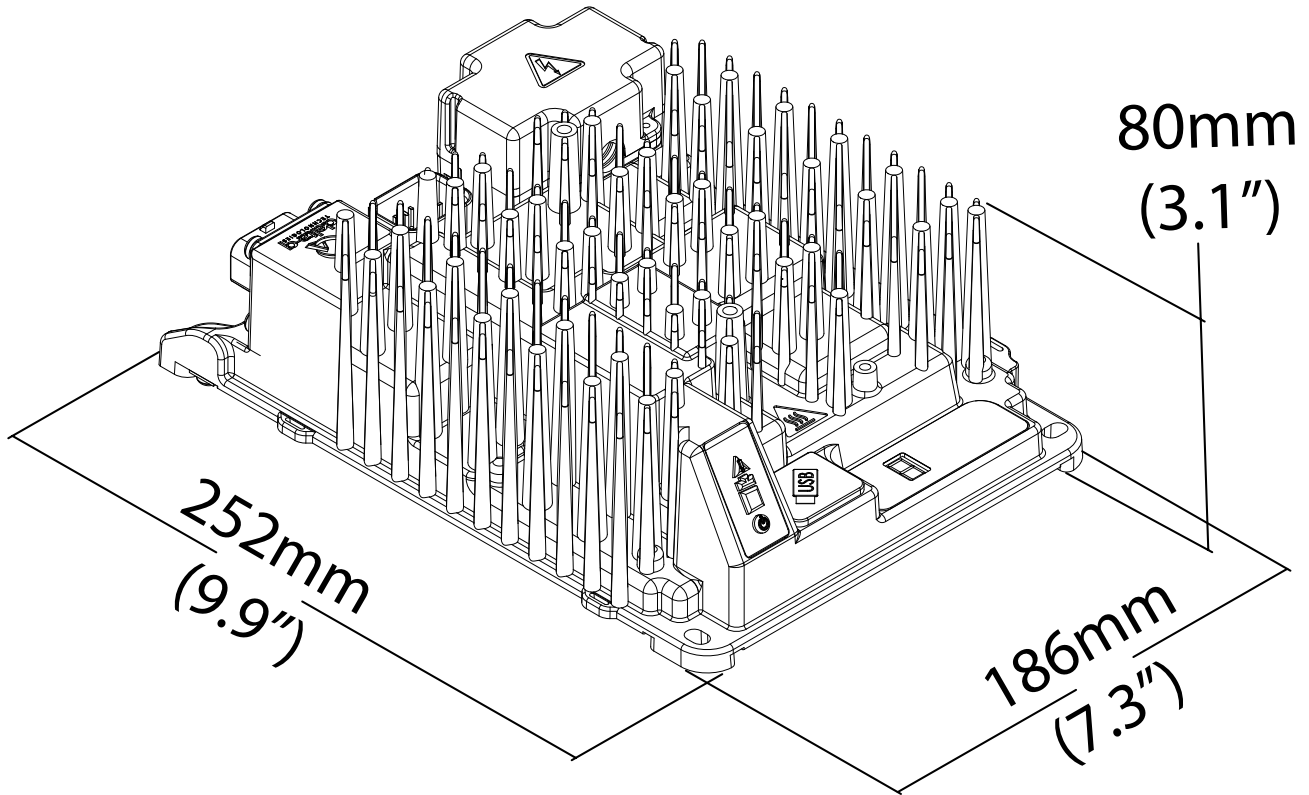

Figure 32. IC650 isometric view and dimensions

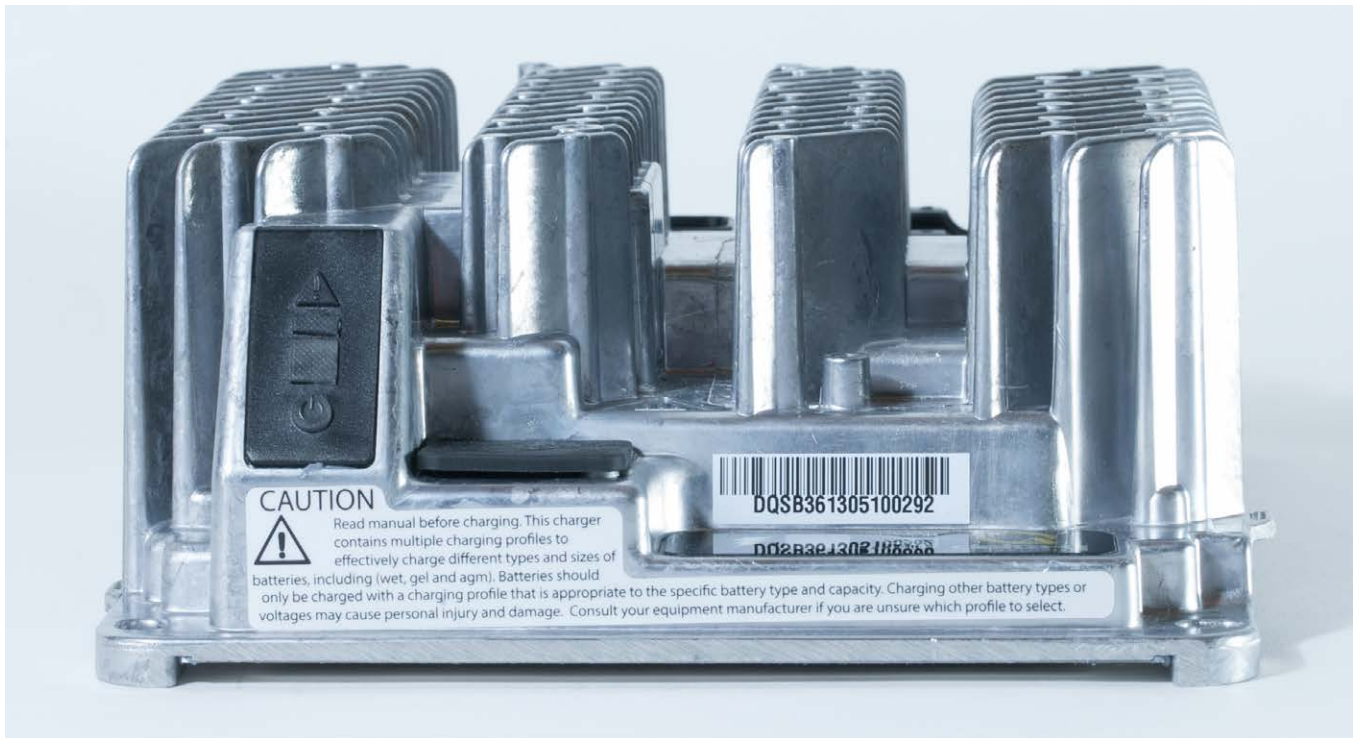

Figure 33. IC650 Front View

10.3 Product Drawings



Figure 34. IC650 Right View



Figure 35. IC650 Left View



Figure 37. IC650 Rear View

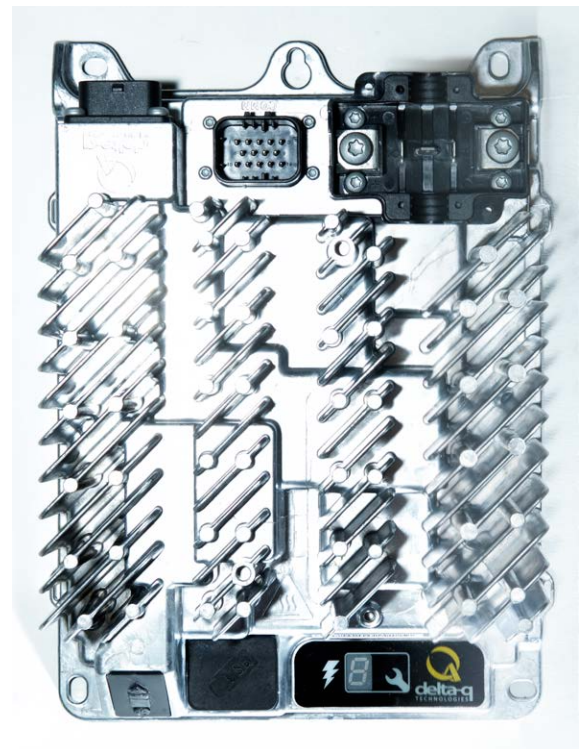

Figure 36. IC650 Top View (Comm Version)

11.0 Replacement Parts List

Part	Part No.	Description
USB port dust cover	400-0299	Covers USB host port from dust / liquid ingress
DC block cover	400-0300	Covers DC terminal fixtures from dust / liquid ingress
DC cord with connector	N/A	DC cord configuration is OEM-specific. Contact Delta-Q for available options
Torx T30 / M6 bolts	410-0365	Bolts for DC positive / negative terminals
M6 square nut	400-0305	Nuts for DC positive and negative terminals
AC cord	900-0063	2m (6.5') 14 AWG IEC320-NEMA5/15
IC650 off-board kit	900-0111	Handle, rubber feet and associated mounting hardware
Isolated battery temperature sensor	900-0056	3m (9.8') bare wires
Isolated battery temperature sensor	900-0059	0.14m (5.5") bare wires
Isolated battery temperature sensor	900-0060	1.2m (47.2") bare wires
Tri-color remote status indicator	900-0058	Remote LED, 3m (9.8') shielded bare wires, tri-color red / yellow / green

12.0 Glossary

Term	Definition
AC	Alternating current
CAN	Controller area network, a standard automotive serial network protocol
DSP	Digital signal processor
DC	Direct current
ELV	Extra low voltage
HV	High voltage
HW	Hardware
ID	Identification
kW	Kilowatt
LED	Light emitting diode
LIN	Local interconnect network, a low-cost automotive serial network protocol
LV	Low voltage
MB	Megabyte, a measure of digital storage space
MCU	Microcontroller - also abbreviated uC or μ C
PC	Personal computer, typically referring to Windows-based systems
PFC	Power factor correction
SW	Software
TBD	To be determined
USB	Universal Serial Bus, a connection technology for attaching peripheral devices to a computer to provide fast data exchange.
VAC	Volts of alternating current

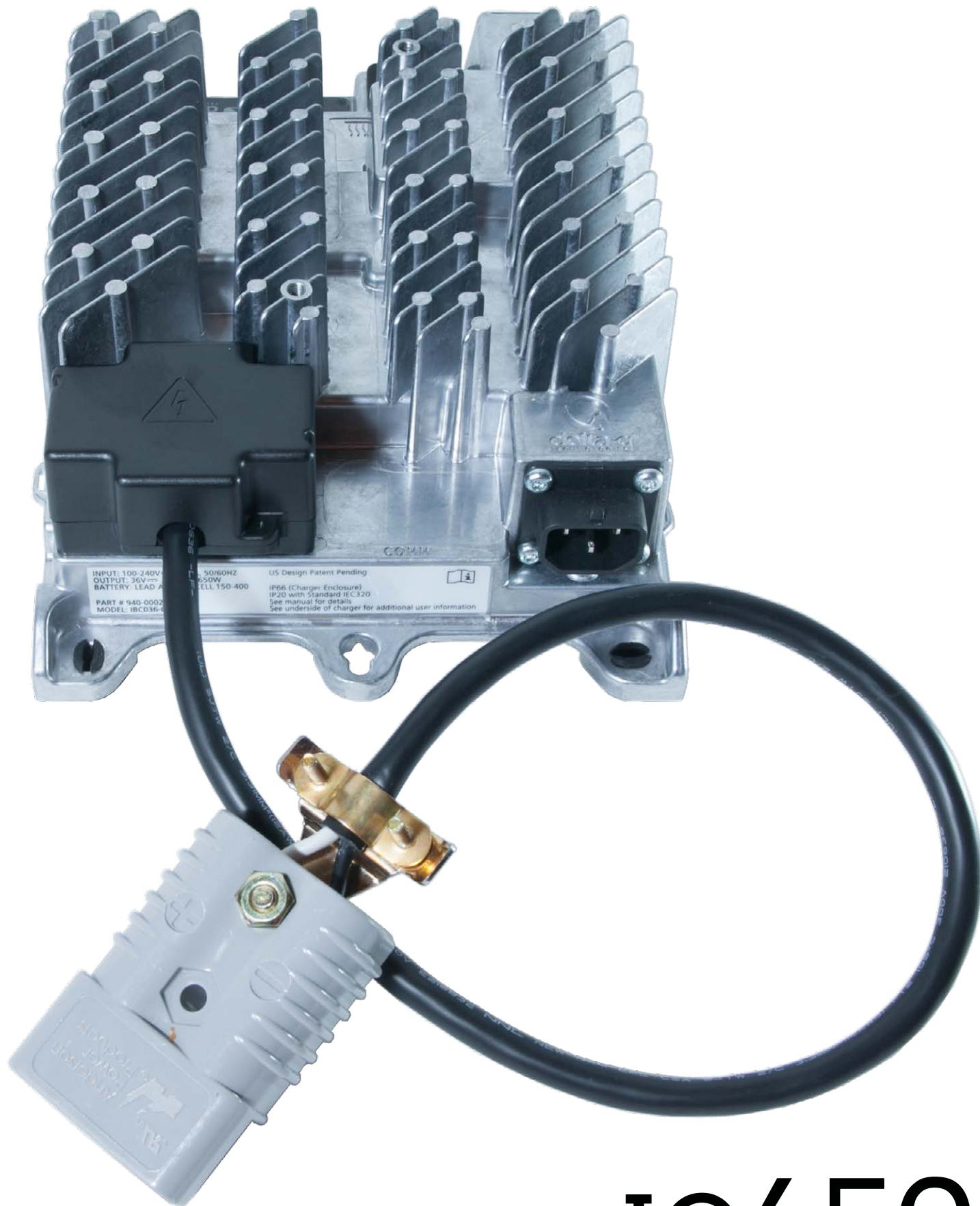

INPUT: 100-240V
OUTPUT: 36V
BATTERY: LEAD-ACID
PART # 940-0002
MODEL: IBC36-0002

50/60HZ
650W
CELL 150-400

US Design Patent Pending
IP66 (Charger Enclosure)
IP20 with Standard IEC320
See manual for details
See underside of charger for additional user information

IC650

www.delta-q.com